

White Paper

Enhanced Performance and Features of the FUJITSU Storage ETERNUS DX8900 S4

This document describes the FUJITSU Storage ETERNUS DX8900 S4, the latest hybrid storage system that achieves world class performance with a focus on scalability and reliability.



Table of Contents

Preface	3
1. Enhanced Performance and Reliability	4
2. CPU Offloading to FPGA	5
2.1. Multi-Engine	5
2.2. Compression/Decompression	5
2.3. Guaranteed Data Integrity	5
2.4. Guaranteed Automatic Data Transfer	5
3. Support of the Data Compression Function	6
4. Enhanced Performance with Extreme Cache	7
5. Data Migration	8
5.1. Non-disruptive Storage Migration	8
5.2. Online Storage Migration	9
5.3. Offline Storage Migration	9
6. Conclusion.....	10

List of Figures

Figure 1-1 Enhanced Performance and Reliability of the ETERNUS DX8900 S4.....	4
Figure 2-1 Improved Performance and Reliability Provided by FPGA.....	5
Figure 3-1 CPU Offloading to the FPGA during Data Compression	6
Figure 4-1 Increased Extreme Cache Capacity	7
Figure 4-2 Extreme Cache Location	7
Figure 5-1 Non-disruptive Storage Migration Overview	8
Figure 5-2 Online Storage Migration Overview	9
Figure 5-3 Offline Storage Migration Overview	9

List of Tables

Table 1-1 Comparison of the Performance between New and Existing Storage Systems.....	4
---------------------------------------------------------------------------------------	---

Preface

Latin for eternal, "ETERNUS" is the global brand name adopted in 2002 by Fujitsu for their storage systems with a mission to "permanently protect our customer's important assets" and "pursue 24/7 uninterrupted operations". Fujitsu has been offering various storage products as well as related services to accomplish this mission.

Among all the ETERNUS branded products, the ETERNUS DX series is especially committed to quality by integrating all production phases (designing, manufacturing, and quality control) in Japan. Through this integration, Fujitsu has been successfully providing high performing, highly reliable, and highly scalable products for our customers' business infrastructures. The ETERNUS DX series is also developed based on the know-how gained from working on mainframe computers.

The FUJITSU Storage ETERNUS DX8900 S4 is a powerful high-end model with high scalability and enhanced features.

It is designed not only for mission-critical systems but also for IoT and AI infrastructures to process big data at high speed.

Fujitsu's goal is to build a Human Centric Intelligent Society, where people can live a high quality of life with a sense of security.

Delivering not only data integrity, which is the backbone of the ICT* society, but also modernization and innovation. Fujitsu continues to contribute to society by offering flexible and innovative solutions that satisfy customers' needs.

*Information and Communication Technology



FUJITSU Storage
ETERNUS DX8900 S4

The product lineup and product information stated in this document are current as of March 2019.

■ Purpose of This Document

This document briefly explains the improved performance and new features of the FUJITSU Storage ETERNUS DX8900 S4 with a focus on enhanced features.

■ Applicable Model

This document covers the following model.
FUJITSU Storage ETERNUS DX8900 S4

■ Terms

The following terms are used in this document.

- FPGA..... Field Programmable Gate Array
Dedicated chip installed with Fujitsu's original software
- CE Controller Enclosure
Main ETERNUS unit
- CM Controller Module
Module that is installed in the CE and controls the internal operations of the ETERNUS
- DE..... Drive Enclosure
Device where storage media such as disk drives and flash drives are installed
- BCC Block Check Code
8 byte check code associated with each block to ensure data integrity
- NVMe..... Non Volatile Memory express
Open industry standard for PCIe based high speed storage. Used in the Extreme Cache feature.

■ Naming Conventions

The following abbreviations are used in this document.

- ETERNUS DX8900 S4 FUJITSU Storage ETERNUS DX8900 S4
- ETERNUS DX8900 S3 FUJITSU Storage ETERNUS DX8900 S3

1. Enhanced Performance and Reliability

The ETERNUS DX8900 S4 features a dedicated FPGA chip that is installed with Fujitsu's original software. The FPGA chip provides the ETERNUS DX8900 S4 with high processing capabilities to significantly improve the performance without affecting the existing reliability.

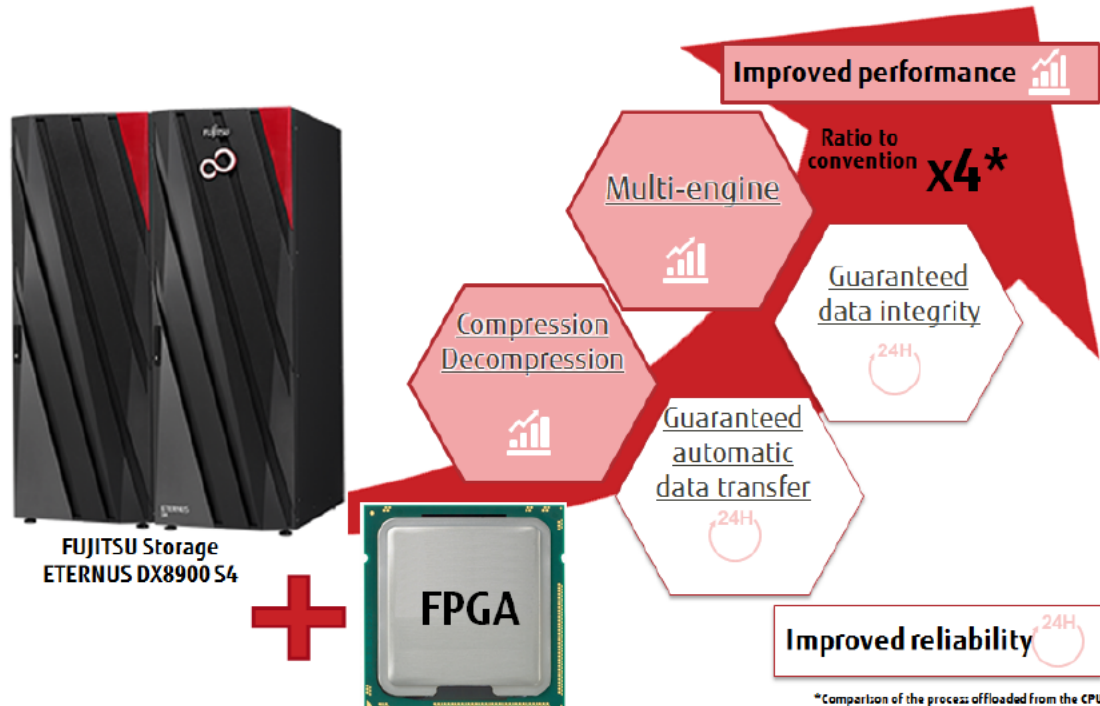

Figure 1-1 Enhanced Performance and Reliability of the ETERNUS DX8900 S4

The ETERNUS DX8900 S4 storage system boasts world class processing capability and scalability, which is a significant improvement over the ETERNUS DX8900 S3. With Intel® Xeon® processors, the ETERNUS DX8900 S4 provides world class performance with a maximum of 10 million IOPs and a response time of 25μ seconds at its fastest to achieve fast data access.

The system memory can be expanded up to 18 TB and the physical capacity can be expanded up to 141 PB by using 6,912 drives.

The ETERNUS DX8900 S4 handles ever increasing data with a scalability and processing capability that far surpasses existing storage systems.

	ETERNUS DX8900 S4	ETERNUS DX8900 S3
Maximum number of controllers	24	24
Maximum number of drives	6,912	4,608
Maximum physical capacity	141 PB	70 PB
Maximum system memory capacity	18 TB	6 TB

For the physical capacity (PB) of the drive, 1 PB = 1,000 TB

Table 1-1 Comparison of the Performance between New and Existing Storage Systems

2. CPU Offloading to FPGA

The ETERNUS DX8900 S4 is equipped with a dedicated FPGA chip installed with Fujitsu's original software. The FPGA executes processes offloaded from the CPU with a performance four times greater than the existing model.

In addition, the FPGA automatically checks the data transfers between the CMs and guarantees system memory mirroring.

The performance of the ETERNUS DX8900 S4 has been improved while retaining the high reliability of the ETERNUS DX8900 S3.

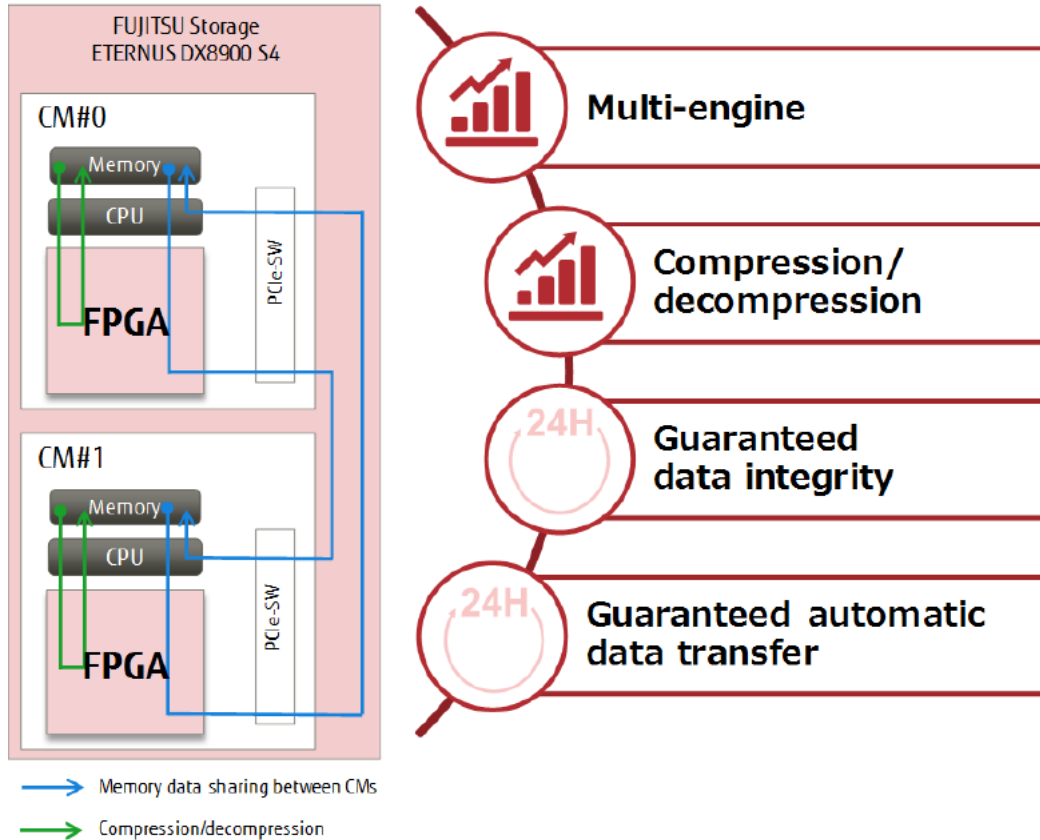

Figure 2-1 Improved Performance and Reliability Provided by FPGA

2.1. Multi-Engine

The FPGA, which is installed with more than one multipurpose engine, executes processes offloaded from the CPU to deliver much higher processing capability than existing models.

2.2. Compression/Decompression

Compression/decompression processes are offloaded to the FPGA by a hardware assist function. This minimizes the performance impact from compression/decompression.

When data is compressed, up to 50% (measured by Fujitsu) of the drive space can be saved and the costs as well as the CPU load can be reduced to speed up the storage system.

High speed BCC check is performed during data compression.

2.3. Guaranteed Data Integrity

Data integrity checks performed in the CPU are offloaded to the FPGA by a hardware assist function. This guarantees data integrity while reducing overhead.

2.4. Guaranteed Automatic Data Transfer

To guarantee data transfer, the FPGA automatically checks the data mirroring of the CM cache and the data transfer state of other CMs.

3. Support of the Data Compression Function

The ETERNUS DX8900 S4 is installed with Fujitsu's original hardware assist function. This function offloads the data compression process, which is an essential function for reducing costs, to the FPGA in real time. As a result, the storage data size can be reduced by up to 50%* without significantly affecting the performance.

Because data compression reduces the amount of data written to the flash drives, it leads to a longer service life of the flash drives. In addition, this guarantees improved reliability of the storage system.

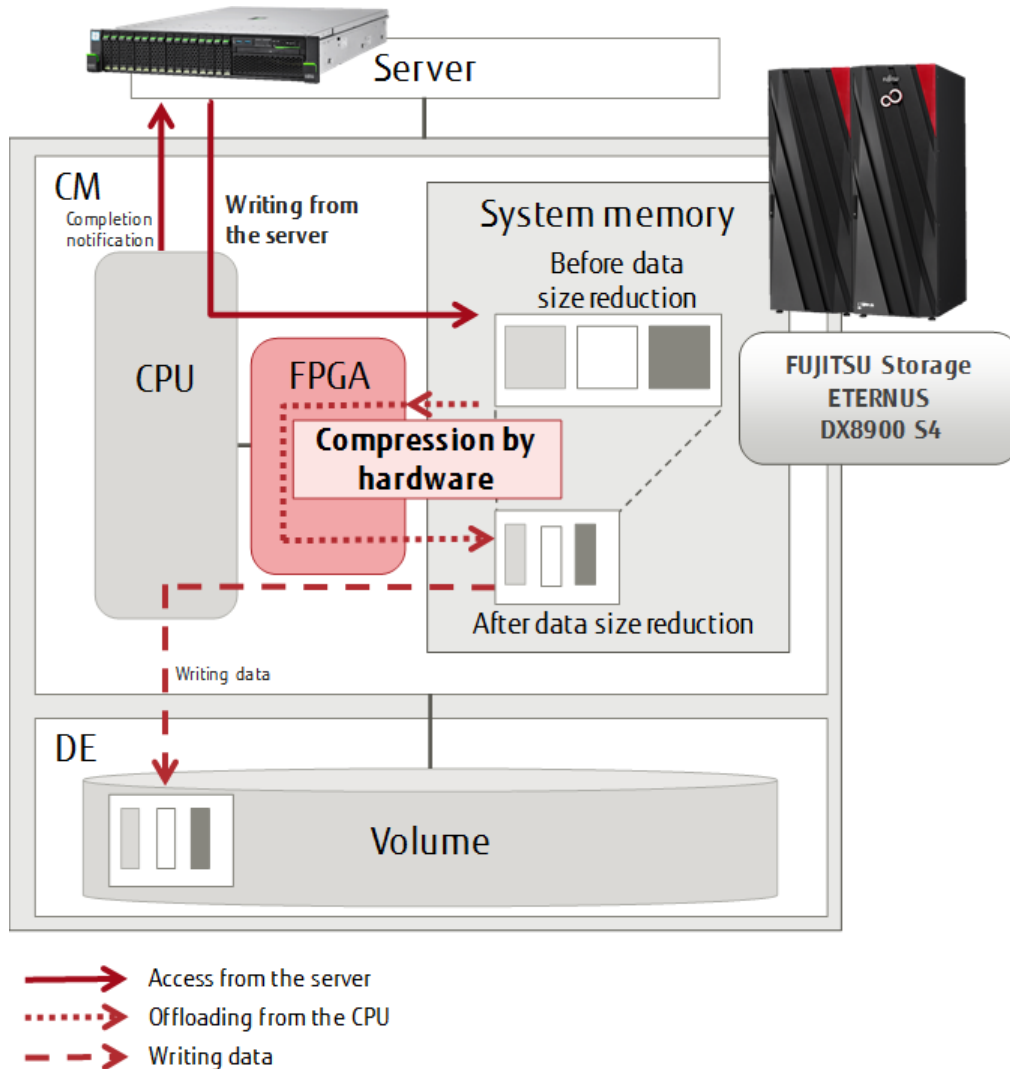

Figure 3-1 CPU Offloading to the FPGA during Data Compression

*Average compression rate for normal data usage

4. Enhanced Performance with Extreme Cache

Extreme Cache is Fujitsu's original function that accelerates the overall performance of a hard-disk based storage system by caching frequently read data in the flash memory with the least additional cost.

The Extreme Cache capacity of the ETERNUS DX8900 S4 can be expanded up to 307.2 TB, or 4.5 times greater than the existing model. This drastically improves the rate of a cache hit for data that could not be found with conventional models. As a result, even hard-disk based storage systems that prioritize costs can provide excellent response performance.

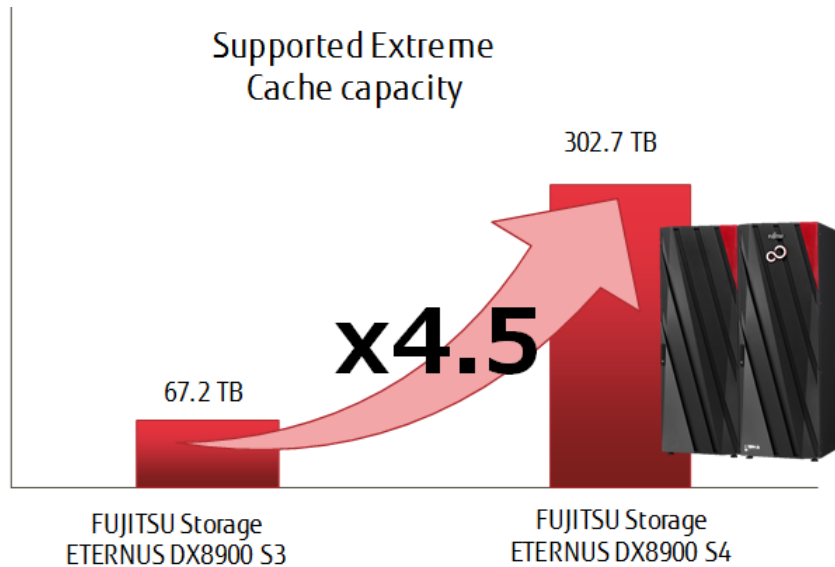

Figure 4-1 Increased Extreme Cache Capacity

Extreme Cache powered by NVMe SSDs is provided in the ETERNUS DX8900 S4 as PCIe Flash Modules (PFM). Because a maximum of eight PFMs can be installed in each CE, the performance can be improved as required.

In addition, the ability to flexibly respond to unexpected changes in operation is another noteworthy feature. Because NVMe SSDs can be simply moved to any CE, the processing performance of an entire system can be optimized immediately.

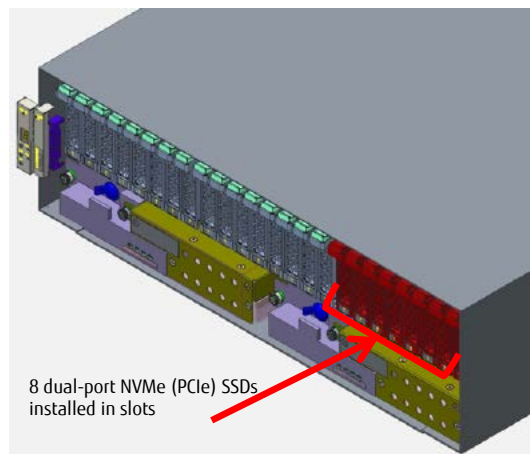

Figure 4-2 Extreme Cache Location

The ETERNUS DX8900 S4 allows flexible configurations based on the customer's needs because the slots for the PFMs can be shared with hard disks or SSDs that configure a data RAID.

5. Data Migration

When migrating data from a source storage system to the ETERNUS DX8900 S4, create paths by connecting the storage systems via FC cables. Data is then read from the source volume and written to the destination via the paths.

The following methods are available according to the operation.

- Non-disruptive Storage Migration
- Online Storage Migration
- Offline Storage Migration

Non-disruptive Storage Migration can be used to migrate data between an ETERNUS DX8900 S4 and a FUJITSU Storage ETERNUS DX series.

5.1. Non-disruptive Storage Migration

Non-disruptive Storage Migration* migrates volume data from a source storage system to a volume in the ETERNUS DX8900 S4 without stopping the business server.

*Must be supported by the source storage system.

This method creates a migration path by connecting the source storage system with the ETERNUS DX8900 S4. With the RAID Migration function, data is read from the migration target volume and written to the destination volume via the migration path. At this time, by matching the identification information of the destination ETERNUS DX8900 S4 volume with that of the source volume, the server recognizes the two separate volumes as a single volume. Then, add the ETERNUS DX8900 S4 to the multipath used by the business server. By configuring and disconnecting the multipath to switch the workload I/Os to the destination ETERNUS DX8900 S4, the migration can be performed using Non-disruptive Storage Migration.

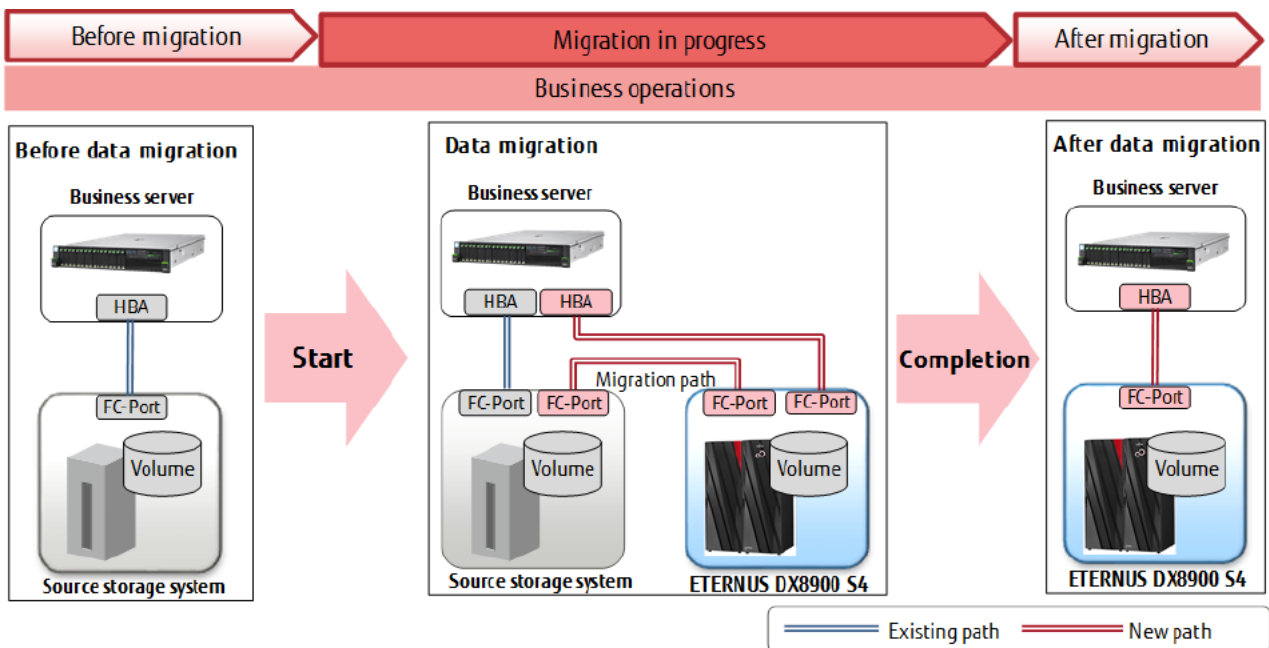

Figure 5-1 Non-disruptive Storage Migration Overview

5.2. Online Storage Migration

With online Storage Migration, business operations must be temporarily suspended because the FC cables must be disconnected from the source storage system and then connected to the ETERNUS DX8900 S4. However, since business operations can be immediately resumed, downtime is significantly reduced. Storage migrations are then performed directly between the source storage system and the ETERNUS DX8900 S4, which reduces the impact on business operations.

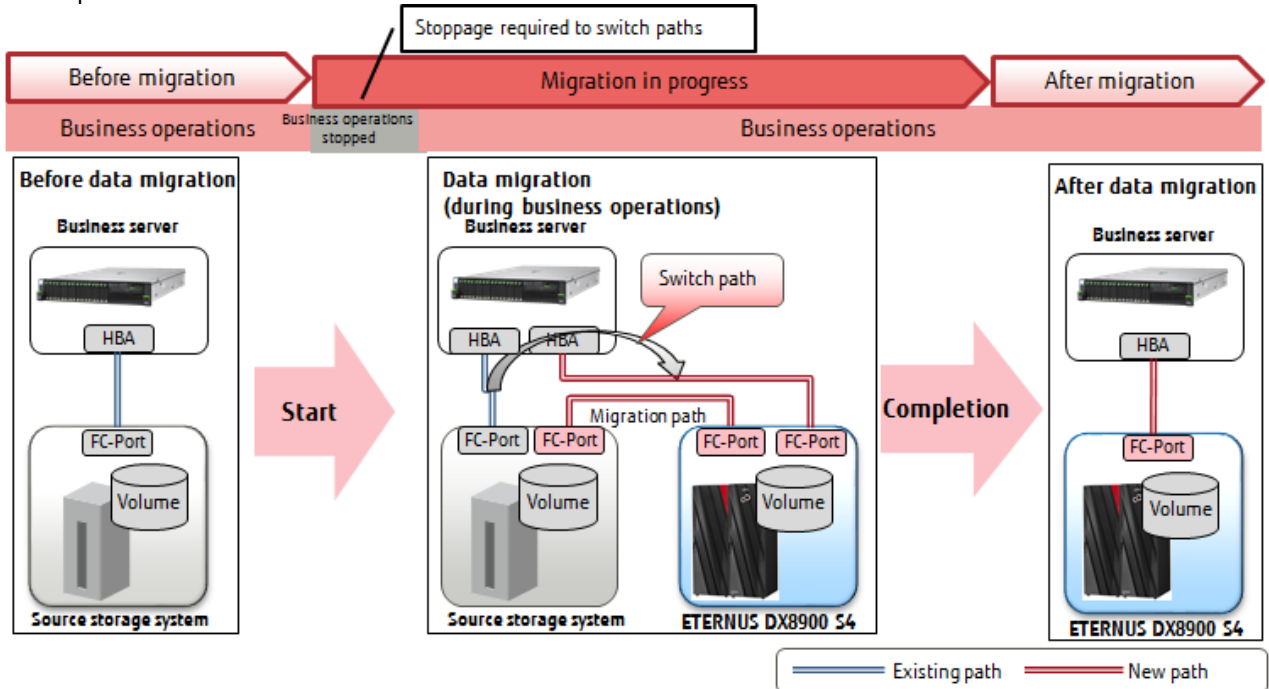

Figure 5-2 Online Storage Migration Overview

5.3. Offline Storage Migration

Although the connection method is the same as online Storage Migration, offline Storage Migration is much faster because business operations are stopped. This method provides a fast, highly efficient migration if business downtime is allowed.

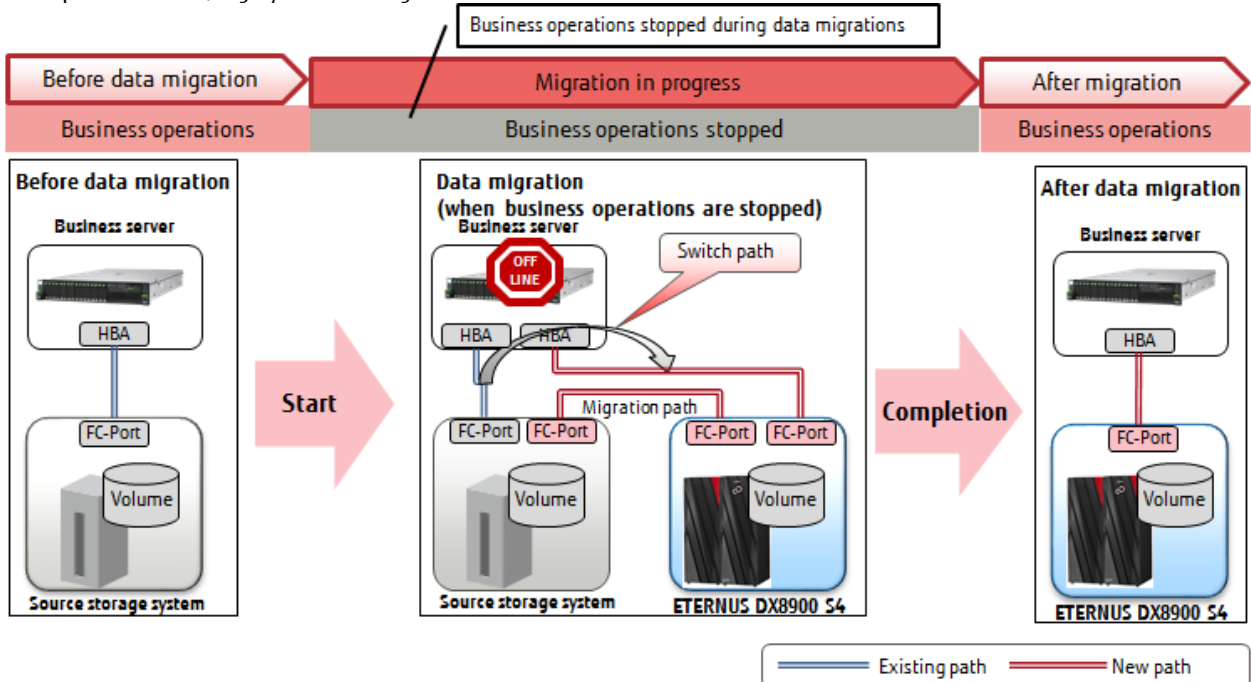

Figure 5-3 Offline Storage Migration Overview

6. Conclusion

The FUJITSU Storage ETERNUS DX8900 S4 features an FPGA that is installed with Fujitsu's original software. This not only improves the access performance and reliability of the data integrity, but also stores data efficiently using data compression technology that reduces the data size in real time.

Large-capacity Extreme Cache can achieve cache hits even when a large amount of data is accessed. This indicates that despite being a disk storage system, the ETERNUS DX8900 S4 can benefit from this function.

In addition, by choosing the best-suited migration method, migrations can be optimized according to the operation.

The FUJITSU Storage ETERNUS, which complies with Fujitsu's mission to "permanently protect our customer's important assets" and "pursue 24/7 uninterrupted operations", is a high performing, highly reliable, and highly scalable world class storage system. The FUJITSU Storage ETERNUS DX8900 S4, the answer to all your data storage needs.

Contact

FUJITSU LIMITED

Website: <http://www.fujitsu.com/eternus/>

■ Registered trademarks

Intel and Xeon are registered trademarks or trademarks of Intel Corporation in the United States. Trademark symbols such as (R) and (TM) may be omitted from system names and product names in this document. The product names and company names in this document are registered trademarks or trademarks of their respective companies.

■ Disclaimer

All rights reserved, including intellectual property rights. Technical data subject to modifications and delivery subject to availability. Any liability that the data and illustrations are complete, actual or correct is excluded. FUJITSU LIMITED is not responsible for any damage or indemnity that might be caused by the content in this document.