

PRIMERGY BX900 Storage Blades

System configurator and order-information guide

Contents

Instructions
Configurator

- Rules BX900 Storage Blades
- Rules BX400 Storage Blades
- I SX910 S1
- II SX940 S1
- III SX960 S1
- IV VSX960
- V SX980 S1
- VI SX980 S2
- VII external Storage via SAS CB



Change report

PRIMERGY Server

Instructions

This document contains basic product and configuration information that will enable you to configure your system via System-Architect.

Only the tool "System-Architect" will ensure a fast and proper configuration of your PRIMERGY server or your complete PRIMERGY Rack system.

Please pay attention to the naming conventions:

BX900 S1	System unit 1st generation
SX910 S1	Tape Storage Blade
SX940 S1	Storage Blade Disk

You can configure your individual PRIMERGY server in order to adjust your specific requirements.

The System configurator is divided into several chapters that are identical to the current price list and PC-/ System-Architect.

Please follow the lines. If there is a junction, you can choose which way or component you would like to take. Go through the configurator by following the lines from the top to the bottom.

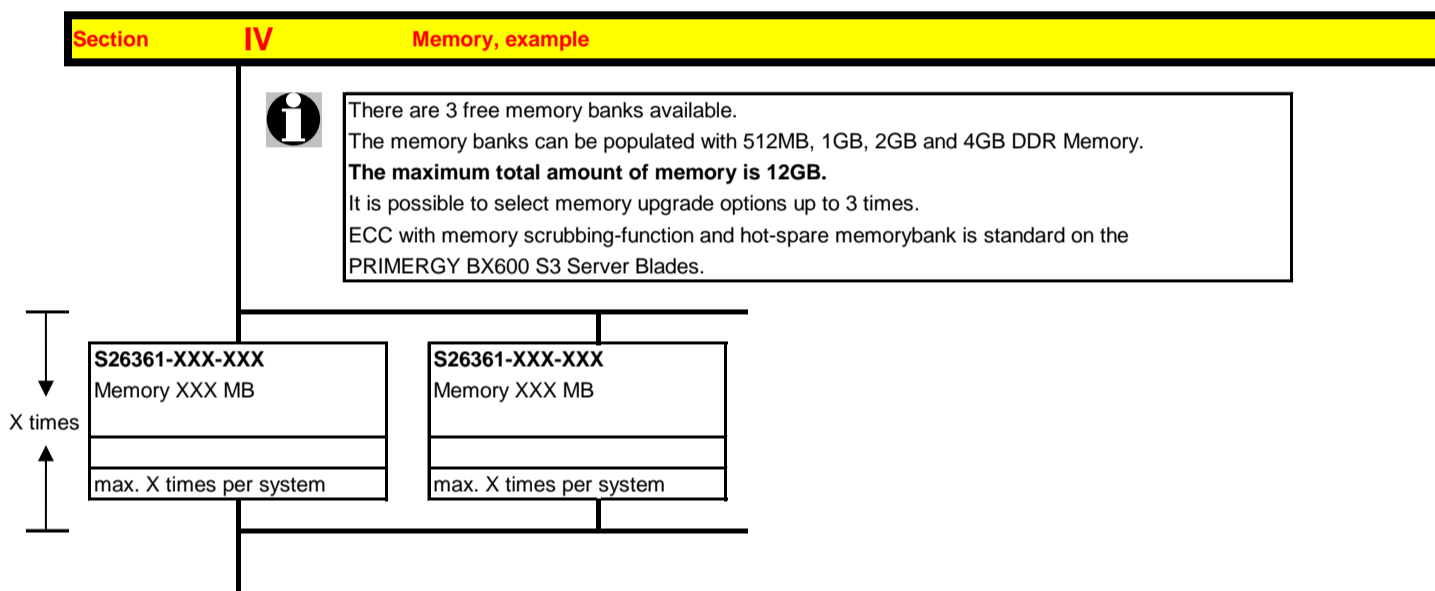

In one chapter you can only select as many components (here 3x) as the arrow indicates.

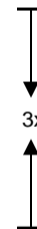

Please note that there are information symbols which indicate necessary information.



For further information see:

http://ts.fujitsu.com/products/standard_servers/index.html (internet)

<https://partners.ts.fujitsu.com/com/order-supply/Pages/default.aspx> (extranet)

Prices and availability see price list and PC-/ System-Architect
 Subject to change and errors excepted

Configuration diagram Storage Blade SX910

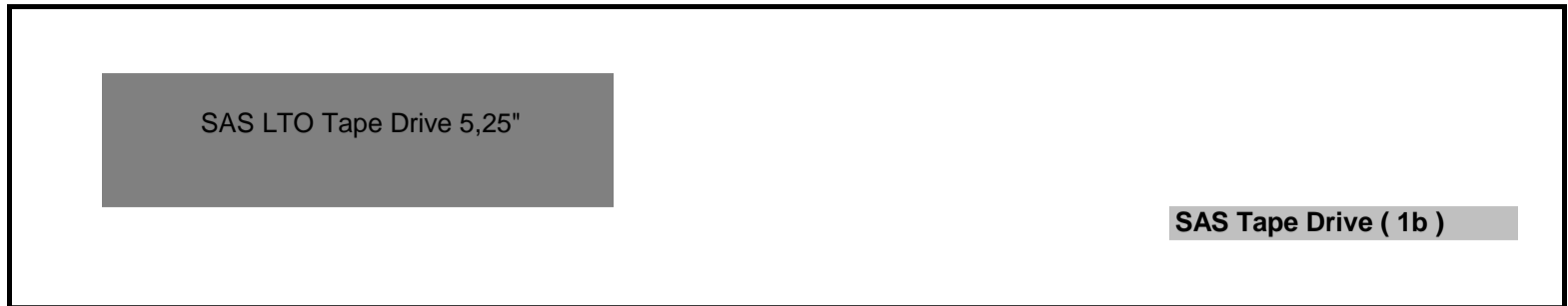

Configuration diagram Storage Blade SX940

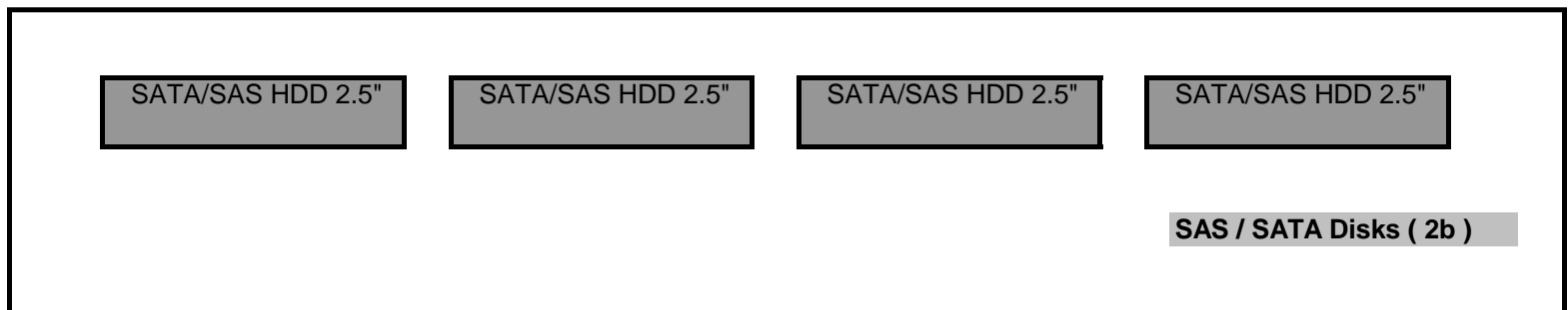

Configuration diagram Storage Blade SX960

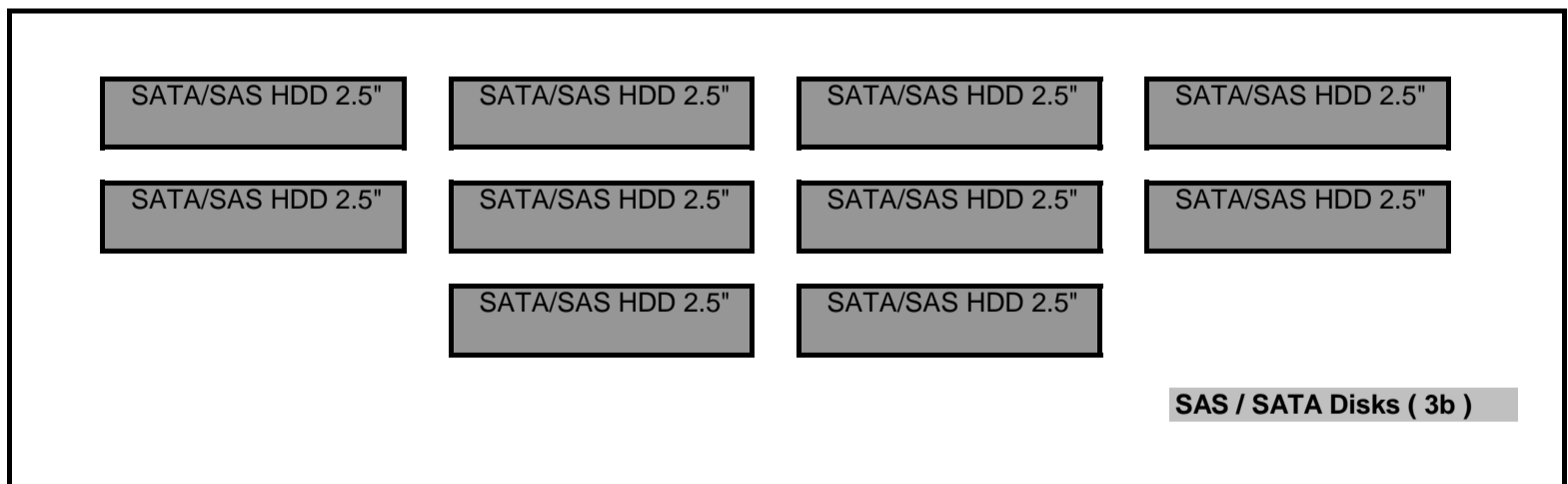

Configuration diagram Storage Blade SX980

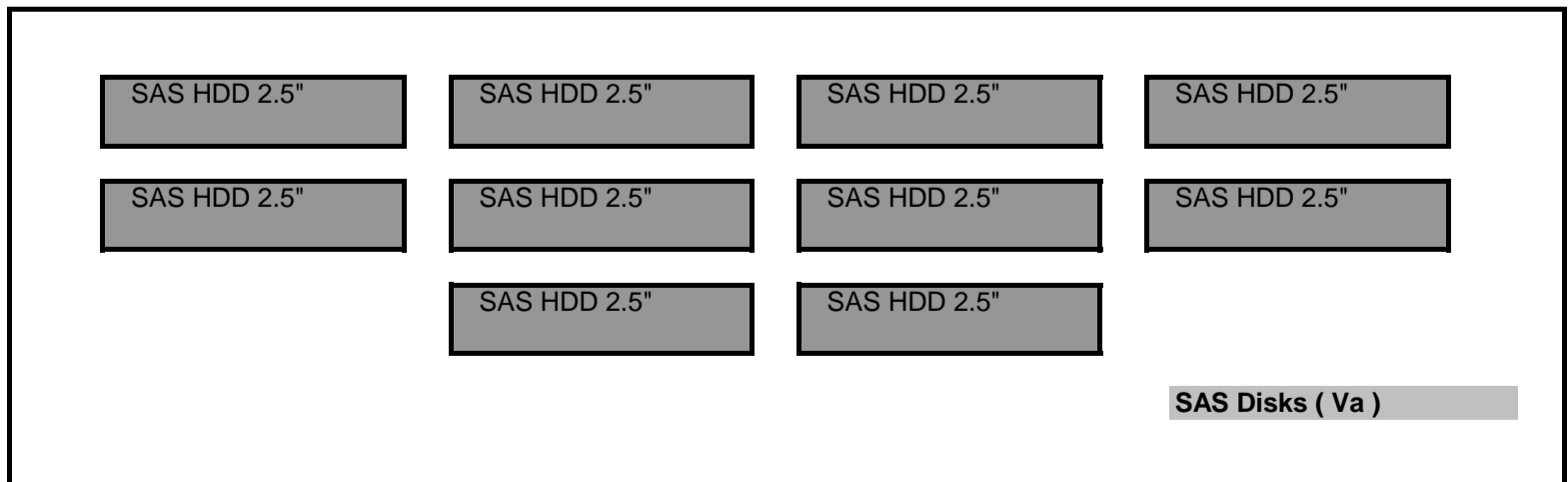

Bright color: included dark color: configurable

Section Rules Storage Blades in System Unit BX900 S2

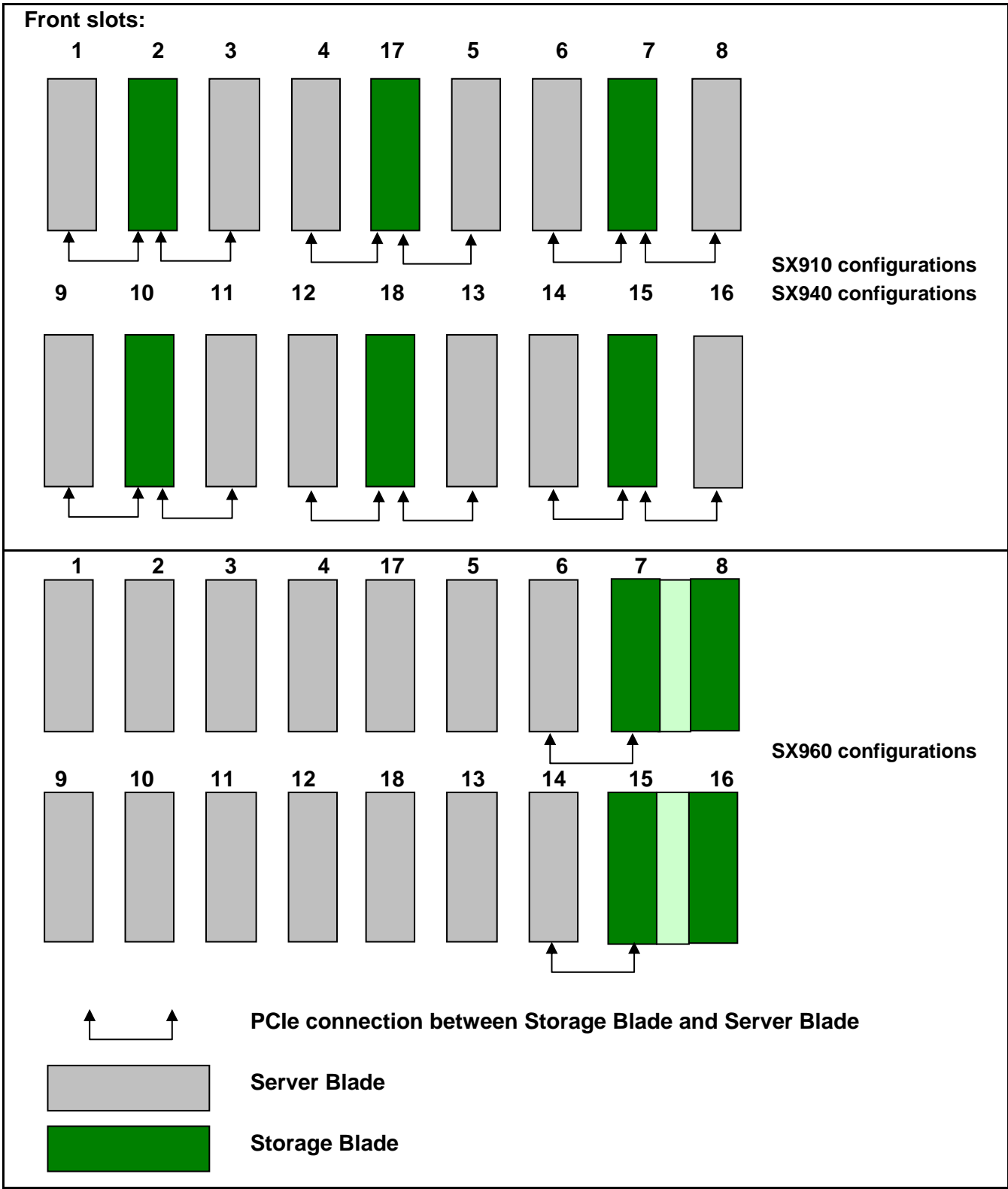

i All described Storage Blades can be inserted into the designated slots of the System Unit.
 For more configuration information see the separate Server Blade configurator at:
<https://partners.ts.fujitsu.com/com/order-supply/Pages/default.aspx>

max. 6x	S26361-K1292-V200	S26361-K1290-V200	S26361-K1383-V220
	PY SX940 S1	PY SX910 S1	PY SX980 S2 JBOD Blade
	Storage Blade Disk	Storage Blade Tape	
	1x or 2x PCIe Controller up to 4x SAS/SATA HDD max. 6x per system unit	1x PCIe Controller 1x SAS LTO Drive max. 6x per system unit	up to 10x SAS HDD redundant SAS pathes max. 6x per system unit

i Due to EMI restrictions, for the US market only
 3x SX980 S2 can be installed in BX900

max. 2x	S26361-K1382-V303
	PY SX960 S2 Storage Blade Disk
	1x SAS/RAID Controller up to 10x SAS/SATA HDD max. 2x per system unit

Q

Section Rules Storage Blades in System Unit BX400 S1

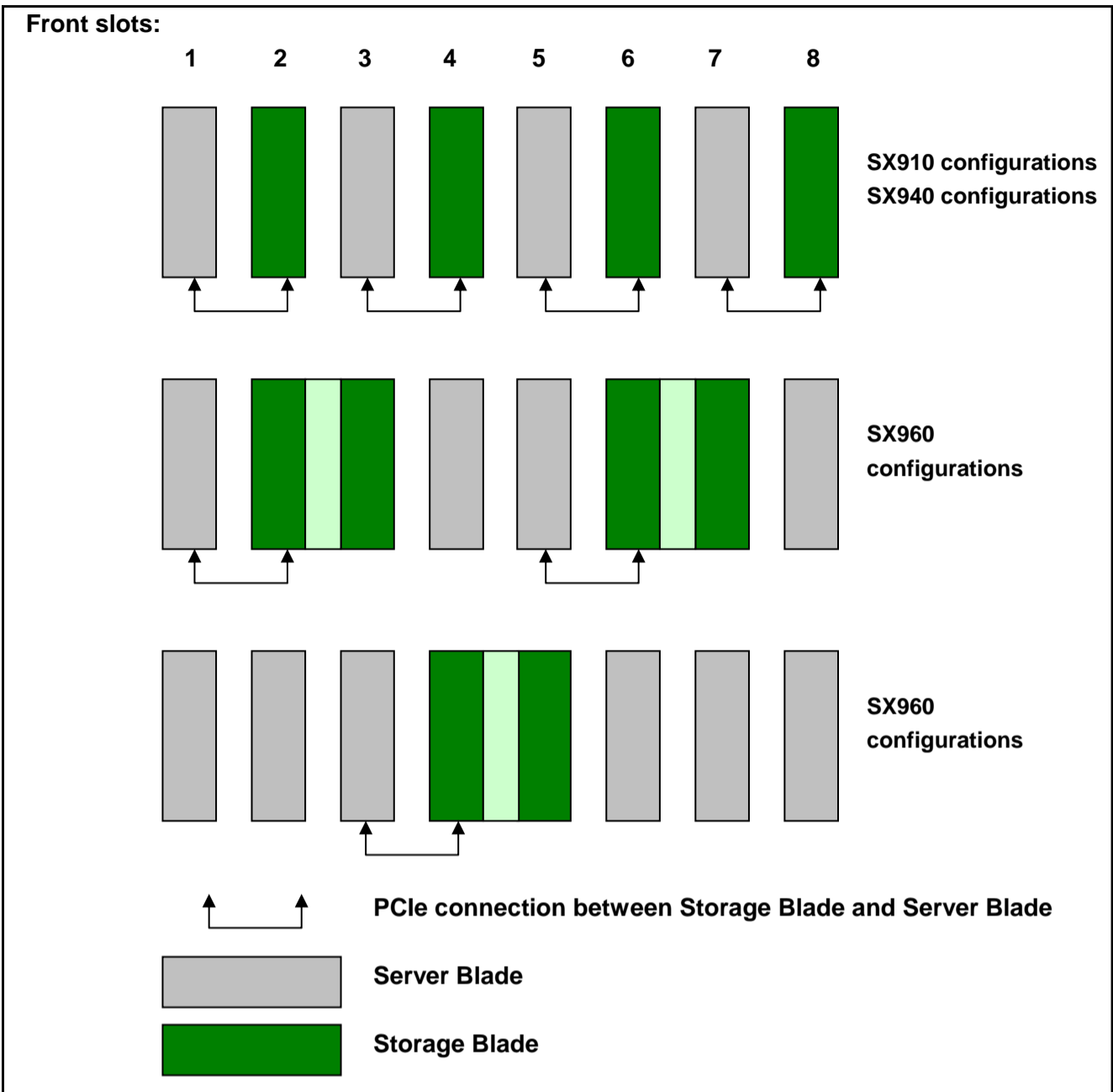

i All described Storage Blades can be inserted into the designated slots of the System Unit.
 For more configuration information see the separate Server Blade configurator at:
<https://partners.ts.fujitsu.com/com/order-supply/Pages/default.aspx>

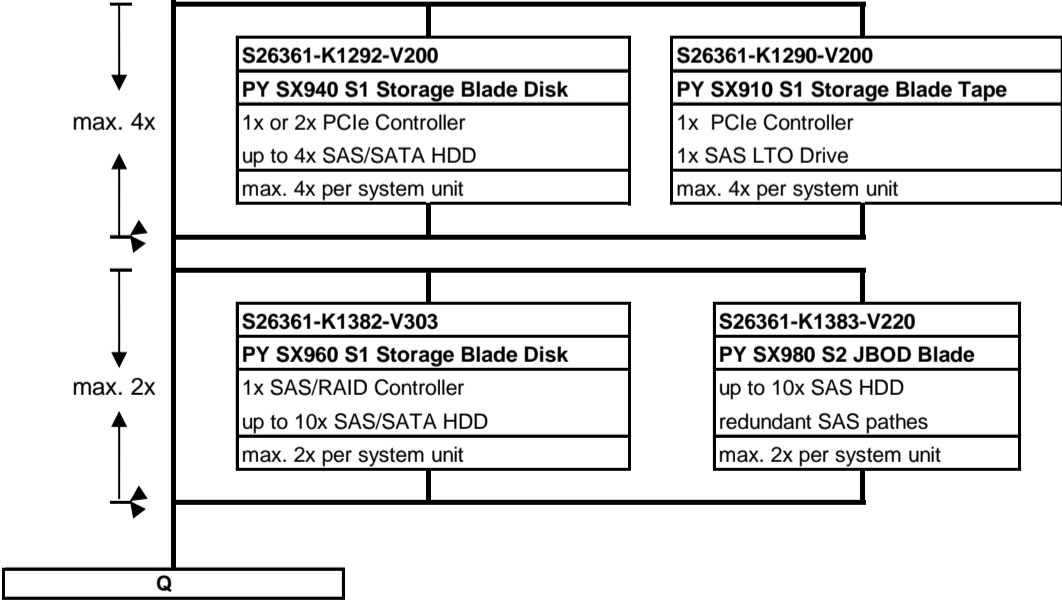

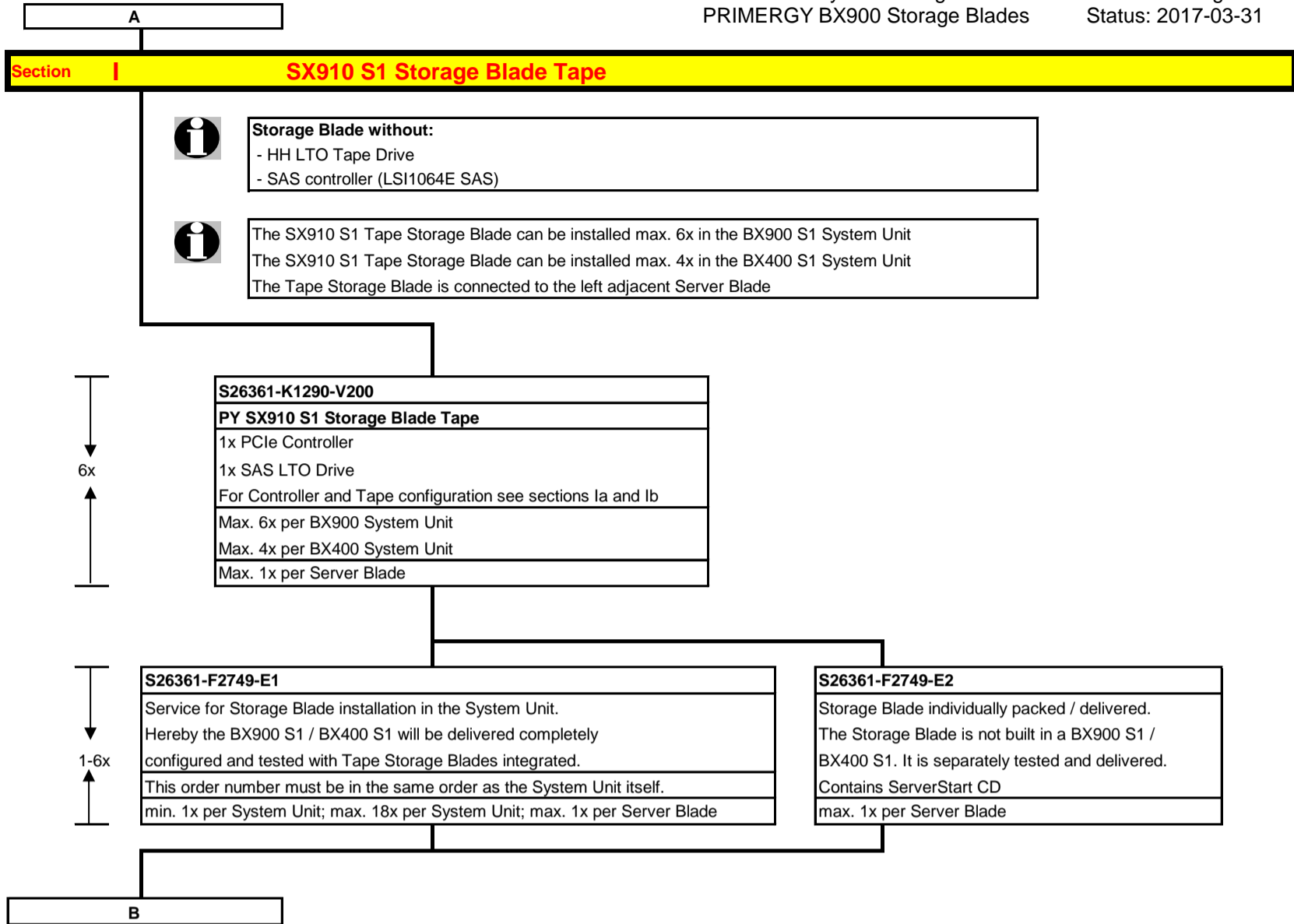

B

Section Ia SAS Controller

i One SAS controller must be configured!

1x

S26361-F3257-E4
4 port SAS RAID Controller
LSI
MegaRAID SAS 1064
no Cache, no BBU
RAID 0, 1 & 1E
SAS 3Gb/sec
4 internal ports
PCIe x4, 160mm
max. 1x per SX910 S1

S26361-F3554-E118
PSAS CP200i
Based on chip LSISAS2008
SAS 6Gb/sec
int: 8 port
PCIe 2.0 x4,
max. 1 per SX910 S1

Section Ib SAS Tape Drives

i One SAS tape drive can be configured!

1x

S26361-F3561-E4
Tape drive LTO3HH Ultrium SAS
400GB, 60MB/s, SAS 3Gb
Connector: mini-SAS
incl. SAS cable
incl. cleaning cartridge
without data cartridge
1.6 * 5.25", black bezel
max. 1x per SX910 S1

S26361-F3626-E2
Tape drive LTO4HH Ultrium SAS
800GB, 120MB/s, SAS 6Gb
Connector: mini-SAS
incl. SAS cable
incl. cleaning cartridge
without data cartridge
1.6 * 5.25"
max. 1x per SX910 S1

S26361-F3627-E1
Tape drive LTO5HH Ultrium SAS
1500GB, 140MB/s, SAS 6Gb
Connector: mini-SAS
incl. SAS cable
incl. cleaning cartridge
without data cartridge
1.6 * 5.25", black bezel
max. 1x per SX910 S1

S26361-F3787-E1
Tape drive LTO6HH Ultrium SAS
2500GB, 160MB/s, SAS 6Gb
Connector: mini-SAS
incl. SAS cable
incl. cleaning cartridge
without data cartridge
1.6 * 5.25"
max. 1x per system

[Back to System Configurator](#)

A

Section II SX940 S1 Storage Blade Disk

Storage Blade with:

- connection to the Server Blades left and right of the Storage Blade depending on configuration
- one or two Hard disk controller (LSI1064/1078 or LSI2008/2108) for up to 4x SAS/SATA HDD's
- first controller will support the left; the second controller will support the right Server blade
- 4 bays for 2.5" SAS/SATA hard disks (hot-plug)
- one or two iBBU (optional for LSI 1078 or LSI 2108)

The SX940 S1 Storage Blade can be installed max. 6x in the BX900 S1 System Unit
 The SX940 S1 Storage Blade can be installed max. 4x in the BX400 S1 System Unit

The SX940 S1 is released with the following Blade Systems and Server Blades:
 BX400S1, BX900 S1 / S2
 BX920 S1 / S2, BX922 S2, BX924 S2, BX960 S1
No release with BX92xS3 Server Blades

6x

S26361-K1292-V200
PY SX940 S1 Storage Blade Disk
 with up to:
 2x SAS controller
 4x Disks
 For Controller and Disk configuration see section IIa and IIb
 Max. 6x per BX900 System Unit
 Max. 4x per BX400 System Unit

1-6x

S26361-F2749-E1
 Service for Storage Blade installation in the System Unit.
 Hereby the BX900 S1 / BX400 S1 will be delivered completely configured and tested with Storage Blades integrated.
 max. 1x per SX940 S1

S26361-F2749-E2
 Storage Blade individually packed / delivered.
 The Storage Blade is not built in a BX900 S1 / BX400 S1. It is separately tested and delivered.
 max. 1x per SX940 S1

Section IIa SAS Controller

One or two SAS controller can be configured!
 - Only one SAS controller can be configured when SX940 will be installed in BX400
 - Up to two SAS controller can be configured when SX940 will be installed in BX900

1-2x

S26361-F3257-E4
 4 port SAS RAID Controller
 LSI
 MegaRAID SAS 1064
 no Cache, no BBU
 RAID 0, 1 & 1E
 SAS 3Gb/sec
 4 internal ports
 PCIe x4, 160mm
 max. 2x per SX940 S1

S26361-F3554-E8
 RAID Ctrl SAS 6G 8port internal
 Based on chip LSISAS2008
 LSI MegaRAID
 no Cache, no BBU
 RAID 0, 1 & 1E
 Support for 3Gb/s and 6Gb/s
 SATA and SAS hard drives
 PCIe x4
 Low-profile MD2 form factor
 max. 2x per SX940 S1

S26361-F3554-E512
 RAID Ctrl SAS 6G 8port internal
 Based on chip LSISAS2108
 LSI MegaRAID
 512MB Cache with ECC
 RAID 0, 1, 10, 5, 50, 6, 60
 optional BBU
 Support for 3Gb/s and 6Gb/s
 SATA and SAS hard drives
 PCIe x4
 Low-profile MD2 form factor
 max. 2x per SX940 S1

S26361-F3554-E118
 PSAS CP200i
 Based on chip LSISAS2008
 SAS 6Gb/sec
 int: 8 port
 PCIe 2.0 x4,
 max. 1 per SX940 S1

S26361-F3257-E116
 Cache Battery Backup Unit
 with 16cm cable set
 max. 1x per controller

B

B

Section IIb SAS / SATA Disks

i Four disks can be plugged in and connected to the controller
 The first controller is connected to the left Server Blade
 The second controller is connected to the right Server Blade
 Configurations with one controller have all disks connected to the left Server Blade
 Configurations with two controllers have two disks connected to each Server Blade

SSD SAS 2.5"

SSD SAS MLC 6Gb/s 2.5" with hot plug/hot replace tray	
100GB MLC,	S26361-F4581-E100
200GB MLC,	S26361-F4581-E200
400GB MLC,	S26361-F4581-E400
Choose up to 3 order codes above.	

SSD SATA 2.5"

SSD SATA MLC 6Gb/s 2.5" with hot plug/hot replace tray	
100GB MLC, Mainstream Performance	S26361-F5225-E100
200GB MLC, Mainstream Performance	S26361-F5225-E200
400GB MLC, Mainstream Performance	S26361-F5225-E400
Choose up to 3 order codes above.	

Business Critical (BC) SATA 6Gb/s HD 2.5" with hot plug/hot replace tray	
250GB 7.200rpm,<9,5ms, 64MB Cache	S26361-F3708-E250
500GB 7.200rpm,<9,5ms, 64MB Cache	S26361-F3708-E500
1000GB 7.200rpm,<9,5ms, 64MB Cache	S26361-F3708-E100
Choose up to 4 order codes above.	

Business Critical (BC) SATA 3Gb/s HD 2.5" with hot plug/hot replace tray	
250GB 7.200rpm,<10,5ms, 8MB Cache	S26361-F3601-E250
500GB 7.200rpm,<10,5ms, 8MB Cache	S26361-F3601-E500
1000GB 7.200rpm,<10,5ms, 8MB Cache	S26361-F3601-E100
Choose up to 4 order codes above.	

SAS 3Gb/s 2.5" with hot plug/hot replace tray	
146GB 15000rpm,<4,5ms, 8MB Cache	S26361-F3292-E514
300GB 10000rpm,<4,5ms, 8MB Cache	S26361-F3292-E130
450GB 10000rpm,<4,5ms, 8MB Cache	S26361-F3292-E145
600GB 10000rpm,<4,5ms, 8MB Cache	S26361-F3292-E160
Choose up to 4 order codes above.	

as long as available
 as long as available
 as long as available
 as long as available

SAS 6Gb/s 2.5" with hot plug/hot replace tray	
300GB 10000rpm,<4,5ms, 8MB Cache	S26361-F4482-E130
450GB 10000rpm,<4,5ms, 8MB Cache	S26361-F4482-E145
600GB 10000rpm,<4,5ms, 8MB Cache	S26361-F4482-E160
900GB 10000rpm,<4,5ms, 8MB Cache	S26361-F4482-E190
Choose up to 4 order codes above.	
SAS 6Gb/s 2.5" with hot plug/hot replace tray	
300GB 10000rpm,<4,5ms, 32MB Cache	S26361-F5247-E130
450GB 10000rpm,<4,5ms, 32MB Cache	S26361-F5247-E145
600GB 10000rpm,<4,5ms, 32MB Cache	S26361-F5247-E160
900GB 10000rpm,<4,5ms, 32MB Cache	S26361-F5247-E190
Choose up to 4 order codes above.	
SAS 6Gb/s 2.5" with hot plug/hot replace tray	
146GB 15krpm,<4,5ms, 8MB Cache	S26361-F4482-E514
300GB 15krpm,<4,5ms, 8MB Cache	S26361-F4482-E530
Choose up to 4 order codes above.	

as long as available
 as long as available
 as long as available
 as long as available

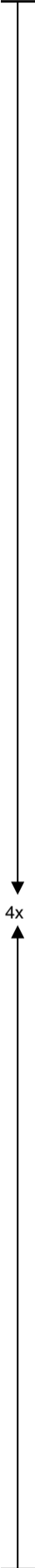

[Back to System Configurator](#)

A

Section III SX960 S1 Storage Blade Disk

Storage Blade with:

- connection to the Server Blade left of the Storage Blade
- 10 SAS 2.0 bays for 2.5" SAS/SATA hard disks (hot-plug)
- one Mega RAID / SAS controller for up to 10x SAS/SATA HDD's
- one iBBU/ FBU optional

The SX960 S1 Storage Blade can be installed max. 2x in the BX400/900 S1 System Unit
 Detailed installation instructions are described in slides "BX400 Storage Blades" and "BX900 Storage Blades"

2x

S26361-K1382-V303
PY SX960 S1 Storage Blade Disk
 with up to:
 1x Mega RAID controller
 10x Disks
 For Controller and Disk configuration see section IIIa and IIIb
 Max. 2x per BX400/900 System Unit

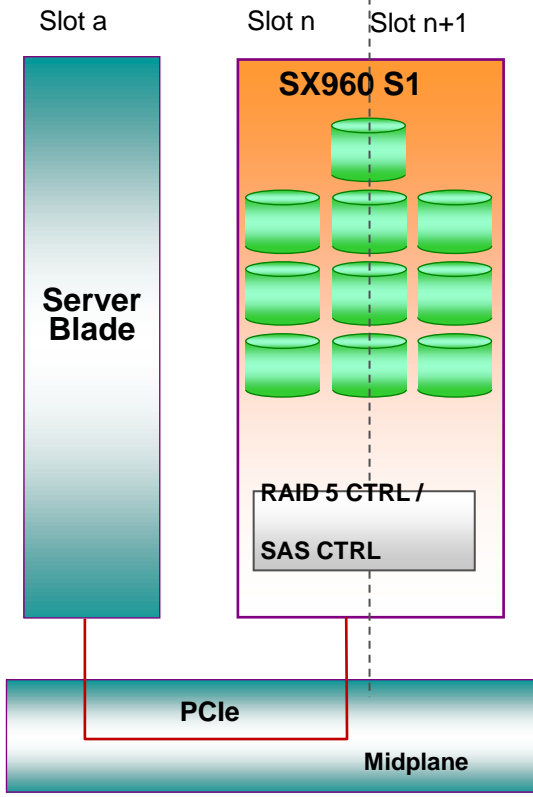

1-2x

S26361-F2749-E1
 Service for Storage Blade installation in the System Unit.
 Hereby the BX400/900 S1 will be delivered completely configured and tested with Storage Blades integrated.
 max. 1x per SX960 S1

S26361-F2749-E2
 Storage Blade individually packed / delivered.
 The Storage Blade is not built in a BX400/900 S1, it is separately tested and delivered.
 max. 1x per SX960 S1

A1

A1

Section IIIa SAS / RAID Controller

i One of the following Mega RAID controller or HBA must be configured!

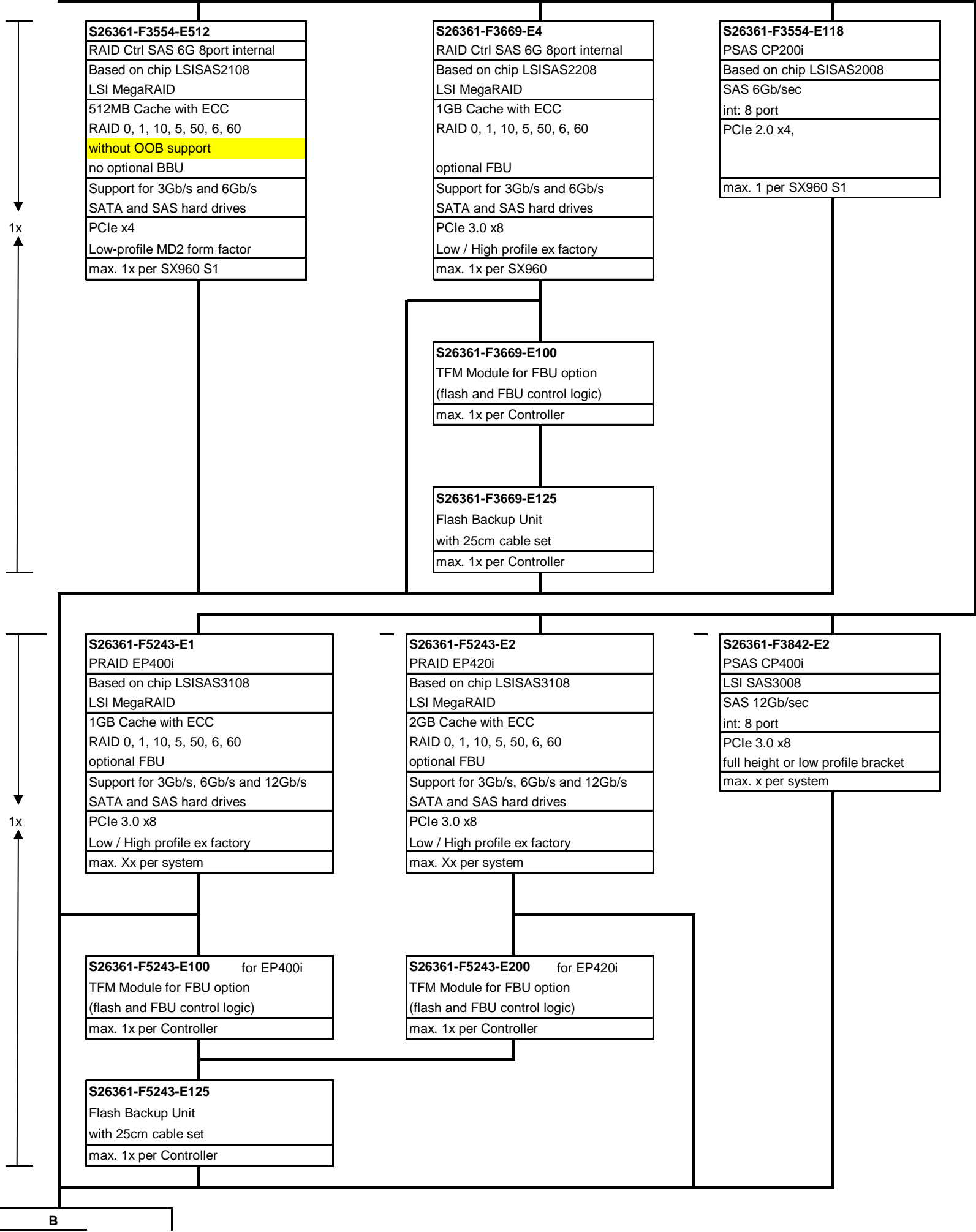

B

Section IIIb SAS / SATA Disks

 Up to 10 disks can be plugged in and are connected to the SAS controller

SSD SATA 6Gb/s 2.5" with hot plug/hot replace tray (H-P)	
240GB, Enterprise (EP), Mixed-Use (3DWPD/5y)	S26361-F5586-E240
480GB, Enterprise (EP), Mixed-Use (3DWPD/5y)	S26361-F5586-E480
960GB, Enterprise (EP), Mixed-Use (3DWPD/5y)	S26361-F5586-E960
1.92TB, Enterprise (EP), Mixed-Use (3DWPD/5y)	S26361-F5586-E192
200GB, Enterprise (EP), Mainstream Endurance (ME)	S26361-F5303-E200
400GB, Enterprise (EP), Mainstream Endurance (ME)	S26361-F5303-E400
800GB, Enterprise (EP), Mainstream Endurance (ME)	S26361-F5303-E800
Choose up to 10 order codes above.	

SSD SAS 12Gb/s 2.5" with hot plug/hot replace tray (H-P)	
480GB, Enterprise (EP), Read-Intensive (1DWPD/5y)	S26361-F5616-E480
960GB, Enterprise (EP), Read-Intensive (1DWPD/5y)	S26361-F5616-E960
1.92TB, Enterprise (EP), Read-Intensive (1DWPD/5y)	S26361-F5616-E192
3.84TB, Enterprise (EP), Read-Intensive (1DWPD/5y)	S26361-F5616-E384
480GB, Enterprise (EP), Read-Intensive (1DWPD/5y)	S26361-F5669-E480
960GB, Enterprise (EP), Read-Intensive (1DWPD/5y)	S26361-F5669-E960
1.92TB, Enterprise (EP), Read-Intensive (1DWPD/5y)	S26361-F5669-E192
3.84TB, Enterprise (EP), Read-Intensive (1DWPD/5y)	S26361-F5669-E384
480GB, Enterprise (EP), 3DWPD (5y)	S26361-F5613-E480
960GB, Enterprise (EP), 3DWPD (5y)	S26361-F5613-E960
1.92TB, Enterprise (EP), 3DWPD (5y)	S26361-F5613-E192
3.84TB, Enterprise (EP), 3DWPD (5y)	S26361-F5613-E384
400GB, Enterprise (EP), 3DWPD (5y)	S26361-F5665-E400
800GB, Enterprise (EP), 3DWPD (5y)	S26361-F5665-E800
1.6TB, Enterprise (EP), 3DWPD (5y)	S26361-F5665-E160
3.2TB, Enterprise (EP), 2.3DWPD (5y)	S26361-F5665-E320
400GB, Enterprise (EP), Mainstream Endurance (ME)	S26361-F5297-E400
800GB, Enterprise (EP), Mainstream Endurance (ME)	S26361-F5297-E800
400GB, Enterprise (EP), 10DWPD (5y)	S26361-F5605-E400
800GB, Enterprise (EP), 10DWPD (5y)	S26361-F5605-E800
1.6TB, Enterprise (EP), 10DWPD (5y)	S26361-F5605-E160
Choose up to 10 order codes above.	

as soon as available
 as soon as available
 as soon as available

as soon as available
 as soon as available
 as soon as available

Business Critical (BC) SATA 6Gb/s HD 2.5" with hot plug/hot replace tray	
1000GB 7.200rpm, <9.5ms, 64MB Cache	S26361-F3708-E100
2.0TB 7.200rpm, 128MB Cache	S26361-F3955-E200
Choose up to 4 order codes above.	

max. 10x

SAS 6Gb/s 2.5" with hot plug/hot replace tray	
300GB 10000rpm, <4.5ms, 32MB Cache	S26361-F5247-E130
600GB 10000rpm, <4.5ms, 32MB Cache	S26361-F5247-E160
900GB 10000rpm, <4.5ms, 32MB Cache	S26361-F5247-E190
1.2TB 10000rpm, <4.5ms, 32MB Cache	S26361-F5247-E112
300GB 15krpm, <4.5ms, 8MB Cache	S26361-F4482-E530
450GB 15krpm	S26361-F4482-E545
600GB 15krpm	S26361-F4482-E560
1000GB 7.200rpm, <9.5ms, 64MB Cache	S26361-F5228-E100
Choose up to 10 order codes above.	

SAS 12Gb/s 2.5" with hot plug/hot replace tray	
300GB 10000rpm, 128MB Cache, 512n	S26361-F5551-E130
600GB 10000rpm, 128MB Cache, 512n	S26361-F5551-E160
900GB 10000rpm, 128MB Cache, 512n	S26361-F5551-E190
1.2TB 10000rpm, 128MB Cache, 512n	S26361-F5551-E112
1.8TB, 10000rpm, 128MB Cache, 512e	S26361-F5544-E118
1TB 7.2krpm, 128MB Cache, 512e	S26361-F5572-E100
2TB 7.2krpm, 128MB Cache, 512e	S26361-F5572-E200
Choose up to 10 order codes above.	

[Back to System Configurator](#)

A

Section V SX980 S2 JBOD Blade

i JBOD Blade with:
 - 10x SAS 2.0 bays for 2.5" SAS hard disks (hot-plug)
 - connection to the Server Blade via SAS Connection Blade and SAS RAID Mezz Card

i Due to EMI restrictions, for the US market only 3x SX980 S1 can be installed in BX900

i Only SAS HDD's / SSD's are supported from SAS CB

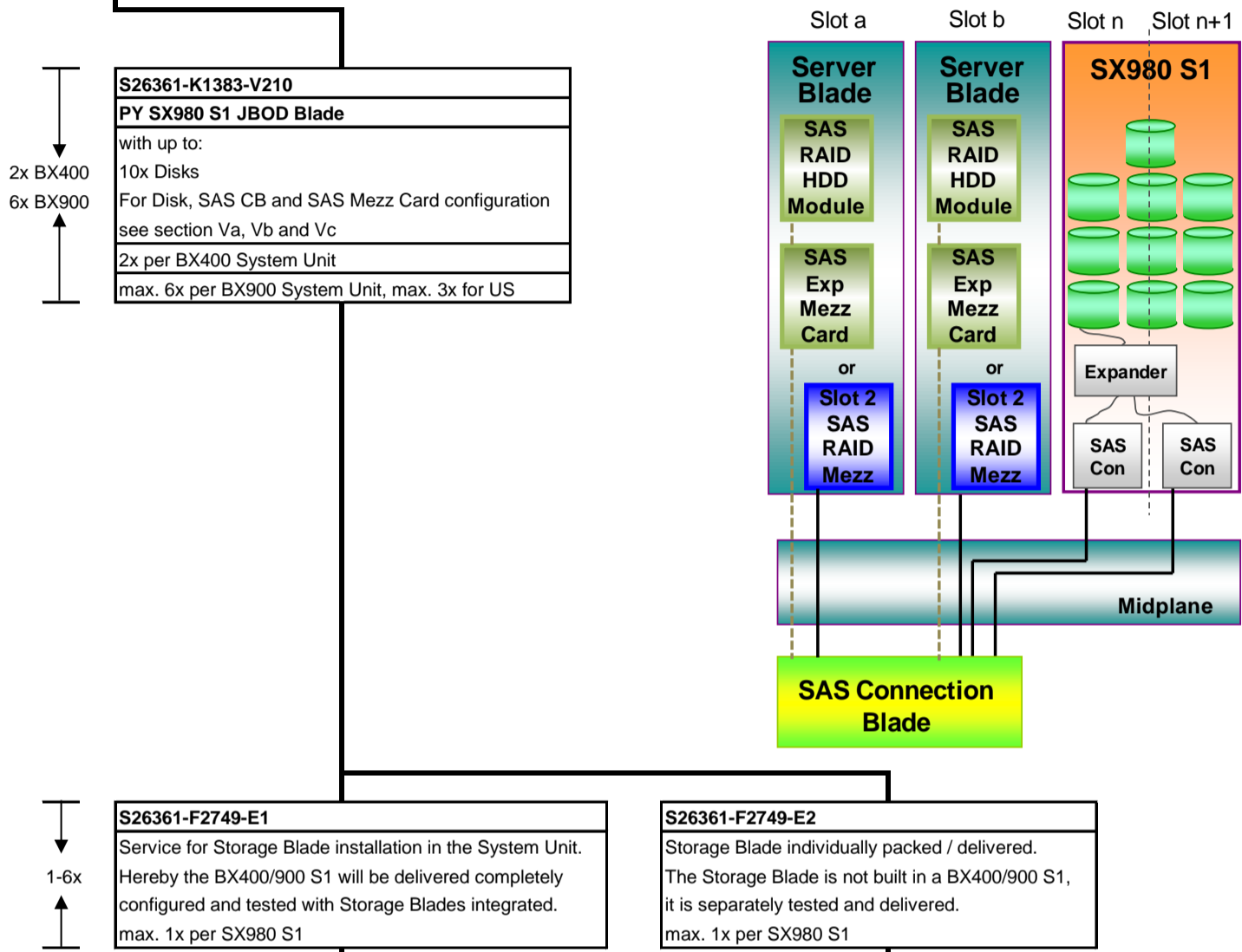

Section Va SAS Disks

i Up to 10 disks can be plugged in and are connected to the Server Blade via SAS CB and SAS RAID Mezz Card

SSD SAS 2.5"

SSD SAS SLC 6Gb/s 2.5" with hot plug/hot replace tray	
400GB SLC, Enterprise Performance	S26361-F4541-E400
SSD SAS MLC 6Gb/s 2.5" with hot plug/hot replace tray	
100GB MLC, Enterprise Performance	S26361-F4581-E100
200GB MLC, Enterprise Performance	S26361-F4581-E200
400GB MLC, Enterprise Performance	S26361-F4581-E400
Choose up to 3 order codes above.	

HDD SAS 2.5"

SAS 6Gb/s 2.5" with hot plug/hot replace tray	
300GB 10000rpm,<4,5ms, 8MB Cache	S26361-F4482-E130
450GB 10000rpm,<4,5ms, 8MB Cache	S26361-F4482-E145
600GB 10000rpm,<4,5ms, 8MB Cache	S26361-F4482-E160
900GB 10000rpm,<4,5ms, 8MB Cache	S26361-F4482-E190
146GB 15krpm,<4,5ms, 8MB Cache	S26361-F4482-E514
300GB 15krpm,<4,5ms, 8MB Cache	S26361-F4482-E530
500GB 7.2krpm,<4,5ms, 64MB Cache	S26361-F5228-E500
1TB 7.2krpm,<4,5ms, 64MB Cache	S26361-F5228-E100
Choose up to 10 order codes above.	

max.10x

B

B

Section Vb SAS Connection Blade

- i** Currently only one SAS CB can be installed in BX400/BX900 enclosure
In a second step, two SAS CB can be configured to realize a redundant connection to SX980 S1
- i** In BX400 the SAS CB must be installed in fabric 3, CB slot 3 (release in slot 4 in second step)
In BX900 the SAS CB must be installed in fabric 3, CB slot 5 (release in slot 6 in second step)
- i** The SAS CB provides 18 internal and 6 external SAS ports
Only SAS HDD's are supported from SAS CB firmware

1x ↓ ↑	S26361-K1391-V300
	S26361-K1391-V400 *)
	PY CB SAS Switch 6Gb 18/6
	SAS Connection Blade
	18 ports internal
	6 ports external (SFF8088)
	Single wide - Single height
1x per SX980 S1	

i *) for separate delivery, without blade chassis

Section Vc SAS Mezzanine Cards

- i** To establish a connection from Server Blade via SAS CB to the SX980 S1 a SAS RAID Mezzanine Card or a SAS RAID HDD module is necessary
- i** If required, an optional iBBU can be installed for the SAS RAID Mezz Card
If required, an optional FBU can be installed for the SAS RAID HDD Module
- i** The SAS RAID Mezz Card has to be installed in Mezz Card slot 2 of the Server Blades

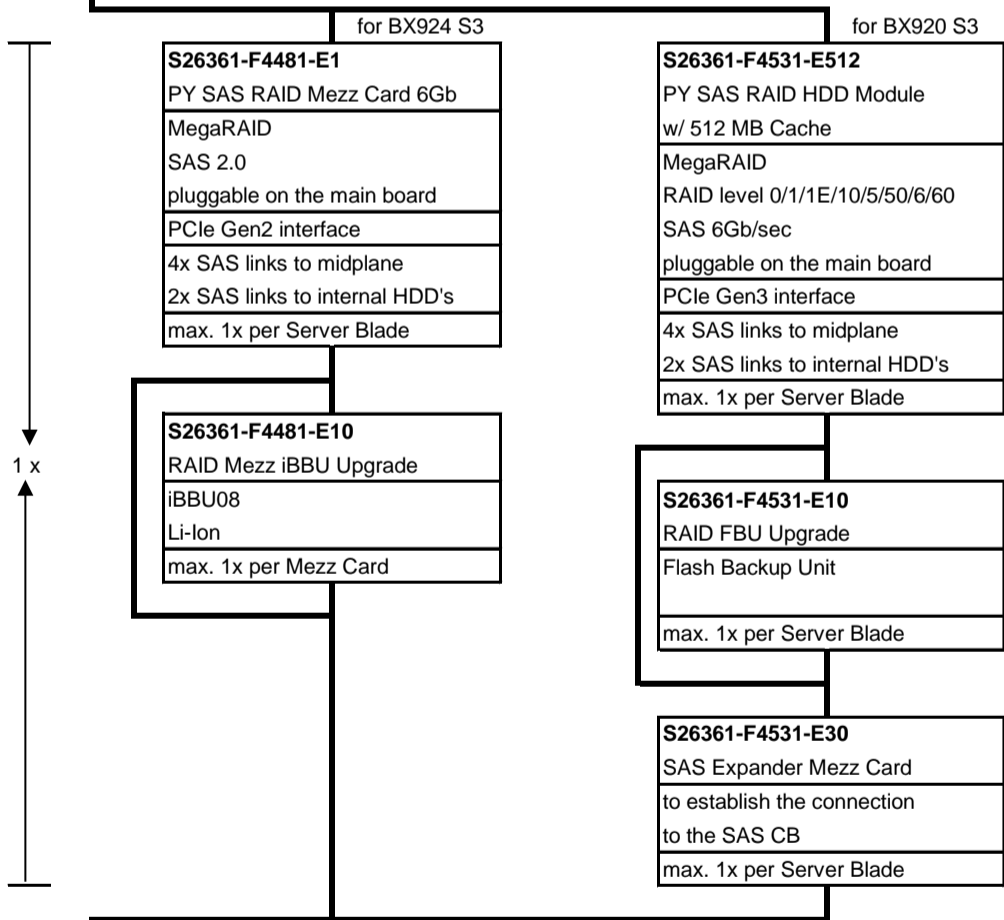

1 x
 ↓
 ↑

Back to System Configurator

Section VI SX980 S2 JBOD Blade for Storage Spaces and Cluster in the Box (CIB) projects

- i** **JBOD Blade with:**
 - 10x SAS 2.0 bays for 2.5" SAS hard disks (hot-plug)
 - redundant SAS paths via SAS CB to SAS Mezz cards on Server Blades
 - connection to the Server Blade via SAS Connection Blade and SAS RAID Mezz Card
- i** **SX980 S2 is released for Cluster in the Box (CIB) in BX400 and Storage Spaces in BX400 / BX900 S2**
- i** **Due to EMI restrictions, for the US market only 3x SX980 S2 can be installed in BX900 S2**
- i** **Only SAS HDD's / SSD's are supported from SAS CB**

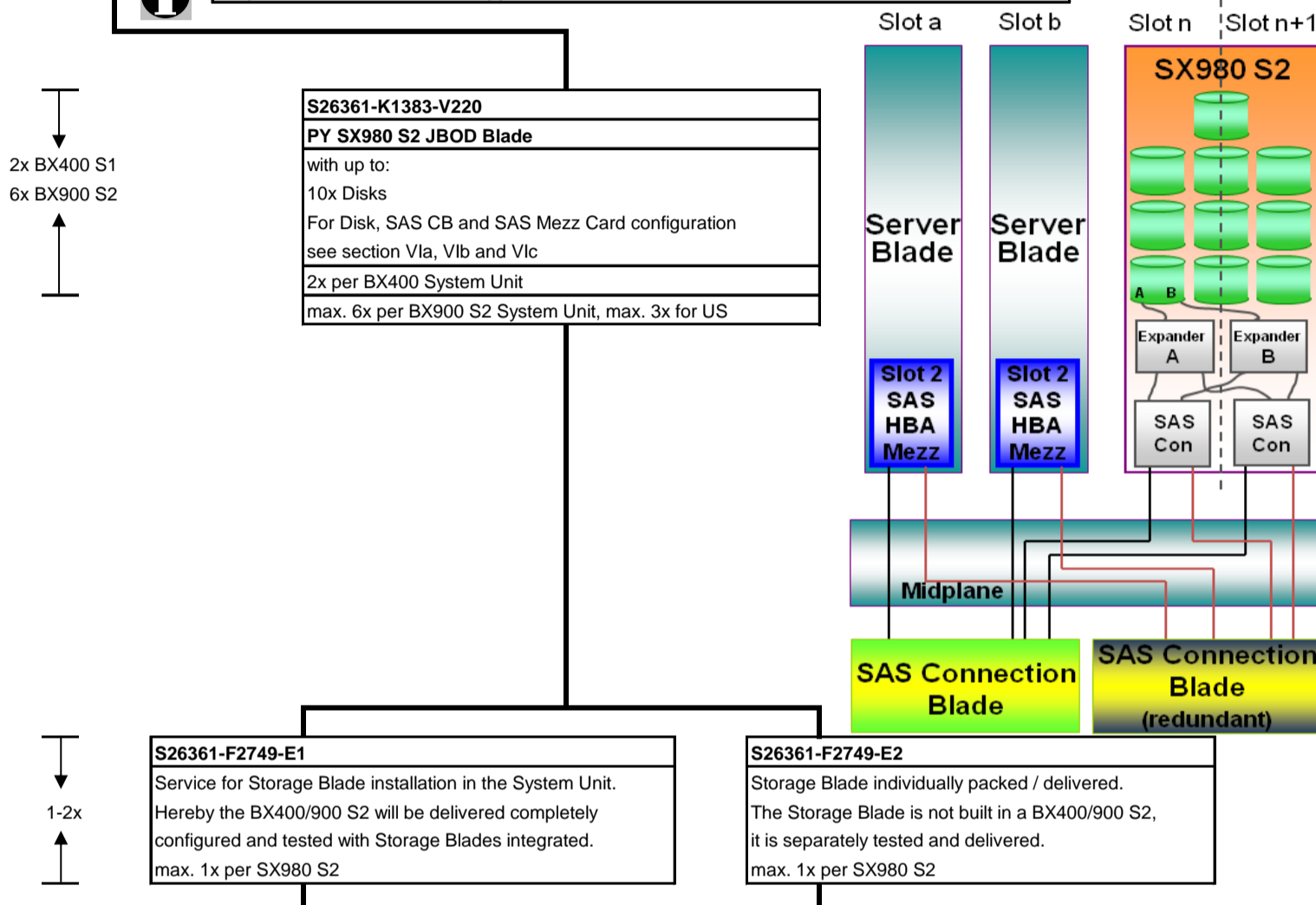

Section VIa SAS Disks

i Up to 10 disks can be plugged in and are connected to the Server Blade via SAS CB and SAS RAID Mezz Card

SSD SAS 2.5"

SSD SAS 12Gb/s 2.5" with hot plug/hot replace tray	
400GB, Enterprise (EP), Mainstream Endurance (ME)*	S26361-F5297-E400
800GB, Enterprise (EP), Mainstream Endurance (ME)*	S26361-F5297-E800
Choose up to 3 order codes above.	

i *) SSD Mainstream Endurance 10DWPD over 5y

support of 12G requires SAS12G controller

SSD SAS 12Gb/s 2.5" with hot plug/hot replace tray (H-P)	
480GB, Enterprise (EP), Read-Intensive (1DWPD/5y)	S26361-F5616-E480
960GB, Enterprise (EP), Read-Intensive (1DWPD/5y)	S26361-F5616-E960
1.92TB, Enterprise (EP), Read-Intensive (1DWPD/5y)	S26361-F5616-E192
3.84TB, Enterprise (EP), Read-Intensive (1DWPD/5y)	S26361-F5616-E384
480GB, Enterprise (EP), Read-Intensive (1DWPD/5y)	S26361-F5669-E480
960GB, Enterprise (EP), Read-Intensive (1DWPD/5y)	S26361-F5669-E960
1.92TB, Enterprise (EP), Read-Intensive (1DWPD/5y)	S26361-F5669-E192
3.84TB, Enterprise (EP), Read-Intensive (1DWPD/5y)	S26361-F5669-E384
480GB, Enterprise (EP), 3DWPD (5y)	S26361-F5613-E480
960GB, Enterprise (EP), 3DWPD (5y)	S26361-F5613-E960
1.92TB, Enterprise (EP), 3DWPD (5y)	S26361-F5613-E192
3.84TB, Enterprise (EP), 3DWPD (5y)	S26361-F5613-E384
400GB, Enterprise (EP), 3DWPD (5y)	S26361-F5665-E400
800GB, Enterprise (EP), 3DWPD (5y)	S26361-F5665-E800
1.6TB, Enterprise (EP), 3DWPD (5y)	S26361-F5665-E160
3.2TB, Enterprise (EP), 2.3DWPD (5y)	S26361-F5665-E320
400GB, Enterprise (EP), 10DWPD (5y)	S26361-F5605-E400

as soon as available
 as soon as available
 as soon as available
 as soon as available

as soon as available
 as soon as available
 as soon as available
 as soon as available

800GB, Enterprise (EP), 10DWPD (5y)	S26361-F5605-E800
1.6TB, Enterprise (EP), 10DWPD (5y)	S26361-F5605-E160
Choose up to 10 order codes above.	

max.10x

SAS 6Gb/s 2.5" with hot plug/hot replace tray	
300GB 15krpm,<4,5ms, 8MB Cache	S26361-F4482-E530
450GB 15krpm	S26361-F4482-E545
600GB 15krpm	S26361-F4482-E560
300GB 10000rpm,<4,5ms, 32MB Cache	S26361-F5247-E130
600GB 10000rpm,<4,5ms, 32MB Cache	S26361-F5247-E160
900GB 10000rpm,<4,5ms, 32MB Cache	S26361-F5247-E190
1.2TB 10000rpm,<4,5ms, 32MB Cache	S26361-F5247-E112
1TB 7.2Krpm,<4,5ms, 64MB Cache	S26361-F5228-E100
SAS 12Gb/s 2.5" with hot plug/hot replace tray	
300GB, 10krpm, 128MB Cache, 512n	S26361-F5551-E130
600GB, 10krpm, 128MB Cache, 512n	S26361-F5551-E160
900GB, 10krpm, 128MB Cache, 512n	S26361-F5551-E190
1.2TB, 10krpm, 128MB Cache, 512n	S26361-F5551-E112
1.8TB, 10krpm, 128MB Cache, 512e	S26361-F5544-E118
1TB 7.2krpm, 128MB Cache, 512e	S26361-F5572-E100
2TB 7.2krpm, 128MB Cache, 512e	S26361-F5572-E200
Choose up to 10 order codes above.	

B

B

Section V1b SAS Connection Blade

- i** In BX400 the SAS CB must be installed in fabric 3, CB slot 3 and slot 4
 In BX900 the SAS CB must be installed in fabric 3, CB slot 5 and slot 6
- i** The SAS CB provides 18 internal and 6 external SAS ports
 Only SAS HDD's are supported from SAS CB firmware

2x ↓ ↑	S26361-K1391-V300
	S26361-K1391-V400 *)
	PY CB SAS Switch 6Gb 18/6
	SAS Connection Blade
	18 ports internal
	6 ports external (SFF8088)
Single wide - Single height	
2x per SX980 S2	

i *) for separate delivery, without blade chassis

Section V1c SAS Mezzanine Cards

- i** To establish a connection from Server Blade via SAS CB to the SX980 S2 in a Storage Spaces or CIB project a SAS HBA Mezzanine Card is necessary
- i** The SAS HBA Mezz Card has to be installed in Mezz Card slot 2 of the Server Blades

1x ↓ ↑	S26361-F4480-E1
	PY SAS HBA Mezz Card 6Gb
	HBA
	SAS 2.0
	pluggable on the main board
	PCIe Gen2 interface
	4x SAS links to midplane
max. 1x per Server Blade	

Back to System Configurator

A

Section VII SAS Connection Blade

- i** Currently only one SAS CB can be installed in BX400/BX900 enclosure
 In a second step, two SAS CB can be configured to realize a redundant connection to external Storage devices
- i** In BX400 the SAS CB must be installed in fabric 3, CB slot 3 and slot 4
 In BX900 the SAS CB must be installed in fabric 3, CB slot 5 and slot 6
- i** The SAS CB provides 6 external SAS ports with SFF8088 connectors for connectivity to external storage

max. 2x

S26361-K1391-V300
S26361-K1391-V400 *)
PY CB SAS Switch 6Gb 18/6
SAS Connection Blade
18 ports internal
6 ports external (SFF8088)
Single wide - Single height
max. 2x per BX400/900

i *) for separate delivery, without blade chassis

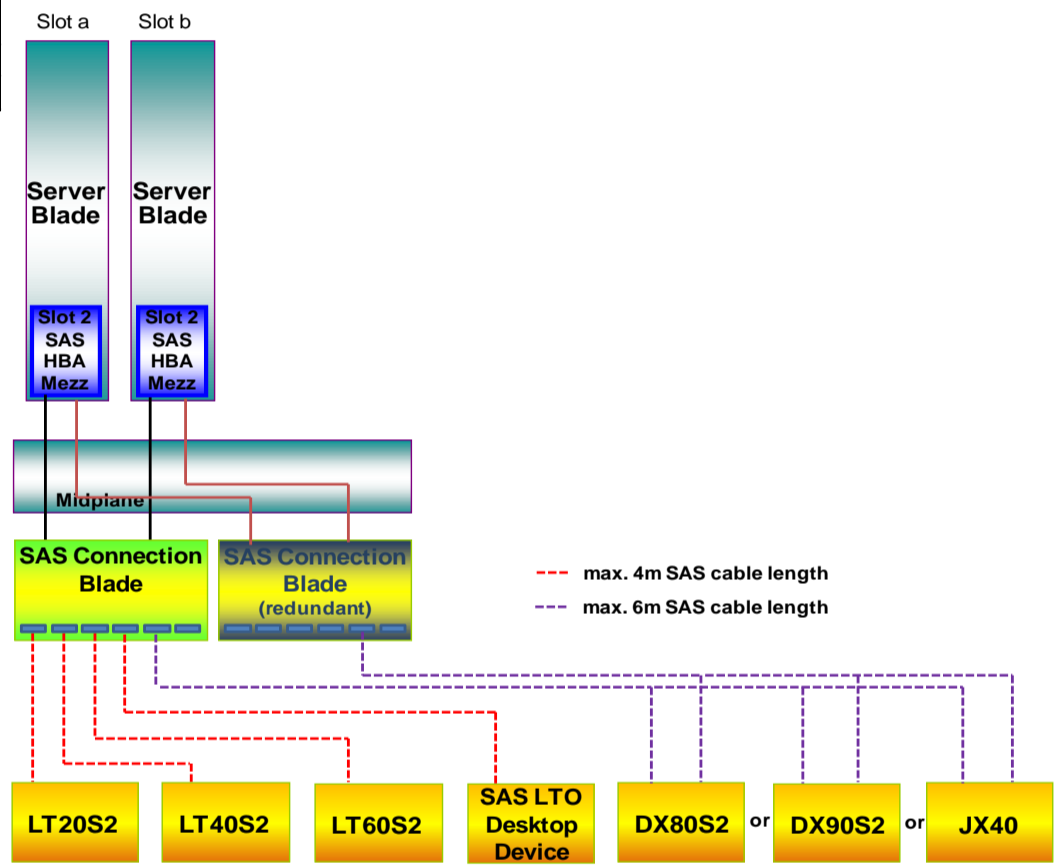

Section VIIa SAS Mezzanine Card

- i** To establish a connection from Server Blade via SAS CB to an external Storage device (LT20S2, LT40S2, LT60S2, DX80S2, DX90S2), a SAS HBA Mezzanine Card is necessary
- i** The SAS HBA Mezz Card has to be installed in Mezz Card slot 2 of the Server Blades

1 x

S26361-F4480-E1
PY SAS HBA Mezz Card 6Gb
HBA
SAS 2.0
pluggable on the main board
PCIe Gen2 interface
4x SAS links to midplane
max. 1x per Server Blade

B

B

Section VIIb External storage devices

i The external storage devices will be connected via SAS interface to SAS CB

i To configure the external storage devices in detail, the corresponding configurator or System Architect has to be used.
 The storage devices has to be configured with SAS drives respectively SAS controller only

i The LTxx tape libraries have to be configured with LTO4 and LTO5 tape devices only
 Every tape device in LTxx tape libraries requires a separate connection to the SAS CB.
 Therefore every tape device occupies one external SAS connector of the SAS CB

i A maximum SAS cable length of 4m between SAS CB and LTxx is strongly recommended

max. 6x ↓ ↑	LT20S2 Eternus LT20S2 Tape Library with max: 1x HH tape device LTO4/LTO5 only requires 1x SAS cable max. 6x per SAS CB	LT40S2 Eternus LT40S2 Tape Library with max: 2x HH tape device or 1x FH tape device LTO4/LTO5 only requires max 2x SAS cable max. 6x per SAS CB	LT60S2 Eternus LT60S2 Tape Library with max: 4x HH tape device or 2x FH tape device LTO4/LTO5 only requires max 4x SAS cable max. 6x per SAS CB	D:LTO-DT-U4S SAS LTO4 Desktop Desktop device with LTO4 HH tape drive included requires 1x SAS cable max. 6x per SAS CB	D:LTO-DT-U5S SAS LTO5 Desktop Desktop device with LTO5 HH tape drive included requires 1x SAS cable max. 6x per SAS CB
-------------------	---	---	---	---	---

i A maximum SAS cable length of 6m between SAS CB and DX80/90 S2 or JX40 is strongly recommended

max. 6x ↓ ↑	DX80S2 Eternus DX80S2 RAID system 2x SAS HCA necessary requires 2x SAS cable max. 6x per SAS CB	DX90S2 Eternus DX90S2 RAID system 2x SAS HCA necessary requires 2x SAS cable max. 6x per SAS CB	JX40 Eternus JX40 2,5" Storage Subsystem 2x IO Module necessary requires 2x SAS cable max. 3x per SAS CB
-------------------	---	---	--

Section VIIc SAS Cable

max. 6x ↓ ↑	for rack internal use S26361-F3246-E880 SAS Cable 6GB 2x SFF8088 connector MiniSAS to MiniSAS customized, 4m or 6m max. 6x per SAS CB	use without Rack		
		D:KBSAS6G-1S-1S-2M SAS Cable 6GB, 2m 2x SFF8088 connector MiniSAS to MiniSAS max. 6x per SAS CB	D:KBSAS6G-1S-1S-4M SAS Cable 6GB, 4m 2x SFF8088 connector MiniSAS to MiniSAS max. 6x per SAS CB	D:KBSAS6G-1S-1S-6M SAS Cable 6GB, 6m 2x SFF8088 connector MiniSAS to MiniSAS max. 6x per SAS CB

[Back to System Configurator](#)

Change Report

Date	Order number	Changes
2017-06-06	Storage	SX960/SX980 S2: S26361-F5665-/F5669-* added, S26361-F5586-E120/F5228-E500 removed
2017-03-21	Storage	SX960/SX980 S2: updated
2016-08-31	S26361-F5605/F5613/F5616-*	SX960/SX980 S2: added
2016-08-08	S26361-F3955-E200	SX960: added
17.08.2015		SX980 description corrected
2015-07-21	S26361-F5247-E1*	added SAS 12G 10K HDDs
2015-04-22	S26361-F3554-E512	Added "no OOB support"
2014-11-25	S26361-F5247-E1*	added SAS 10K 300/450/600/900GB
2014-11-25	S26361-F4482-E1*	EOL SAS 10K 300/450/600/900GB
2014-07-22	S26361-F3842-E2	added PSAS CP400i / Lynx 4
2014-07-22	S26361-F5243-E1/E2	added PRAID CP4x0i / Cougar 4 added
2014-07-22	S26361-F5243-E100/E200	added TFM Module for FBU Option PRAID CP4x0i / Cougar4
2014-07-22	S26361-F5243-E125	added FBU Option for PRAID CP4x0i / Cougar4
2014-07-22	S26361-F3554-E512	no optimal BBU / Removed S26361-F3257-E216 BBU Option
2014-04-17	S26361-F5297-E*	New order codes for SAS 12G SSD's.
2014-04-17	S26361-F4581-E*	EOL for SSD SAS 6G.
2014-04-17	S26361-F3257-E216	FBBU corrected to from S26361-F3257-E116 to S26361-F3257-E216
2014-04-17		Cougar 3: S26361-F3669-E4 released
2014-04-17		corrections in naming SX980 S1 S2
2014-03-05	S26361-K1383-V210	SX980 S1 removed due to VS65
2014-03-05	S26361-K1382-V303	SX960: New Chassis with FBU capability
2014-03-05	S26361-F3669-E*	SX960: Cougar 3 incl. FBU and TFM options added
2013-11-21	S26361-F3554-E118	PSAS CP200i added
2013-05-13	S26361-F3787-E1	LTO6 added
2012-12-21		removed sheet "VSX960" Storage Blade Disk in combination with Data ONTAP-v no longer available
2012-11-30	S26361-F5228-E500/E100	add 2.5" BC-SAS HDD
2012-06-28	S26361-F4541-E200	EOL SSD SAS 200GB SLC
2012-06-25	S26361-F4581-E*00	New order for SAS SSD's
2012-06-11	S26361-F5225-E*00	New order for SATA SSD's
2011-12-21	S26361-F4482-E114	SAS HD 6G 144GB - no longer available
2011-10-01	S26361-F3601-E250	new BC SATA HD - now available
2011-10-01	S26361-F3298-E64	64 GB SSD - no longer available
2011-06-08		Added SX980
2011-03-02		Corrected SX940 positioning and count from 8x -> 6x
2011-02-05	S26361-K1382-V200	Added SX960
2010-09-13	S26361-F3626-E1	Upgrade SX910 - New LTO4 SAS drive
2010-07-16		Added LTO5 and SAS 6GB HDD, Revised configurator completely
2010-03-01		Separate Configurator for SX9xx Storage Blades
2010-02-22		Update in Memory Configuration BX924
2010-02-09	S26391-F264-L226	USB Floppy drive will be phased out by end of February 2010 with no alternative
2010-02-05		Removed BX924 Extra CPUs
2010-02-05		Added Remark for QA about UFM
2010-01-18		Removed FDD - no replacement
2009-12-17		Added CPU order codes for BX920 S2 & BX922 S2
2009-12-08		Added SSD Kit
2009-11-11		Update to BX922 /BX922 Westmere SKUs
2009-08-25		Added BX922 BX924
2009-08-25		modified SSD to 32 /64GB Intel types
2009-07-31	S26361-K1290-V200	SX910 - now available
2009-05-25		USB Device update BX920
2009-04-22		SSD 50GB comment added "as soon as available"
2009-03-31		First release